

OP.630P.24VDC Pull Type Open Frame Linear Solenoid

Duty cycle (%) = $\frac{\text{"ON" time}}{\text{"ON" time} + \text{"OFF" time}} \times 100$		Continuous (100%)	Or less (50%)	Or less (25%)	Or less (10%)	
MAX. "ON" time in seconds		∞	55	19	3	
Watts at 20°C		2.4	4.8	9.6	24	
Ampere-turns at 20°C		432	615	864	1368	
Type No.	Resistance (20°C) $\Omega \pm 10\%$	No. Turns	Volts DC			
OP.630P.24VDC.100%	240	4320	24	34	48	76

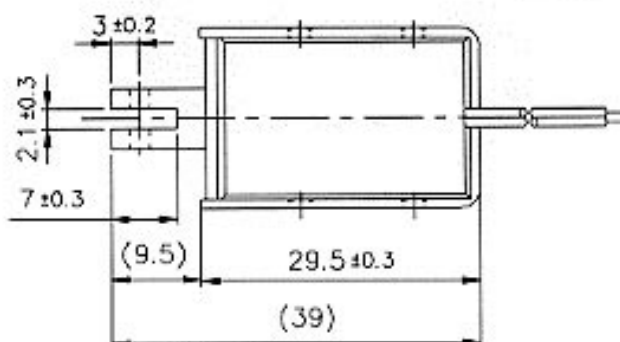

OP.630P.24VDC
Pull Type Open Frame Linear Solenoid

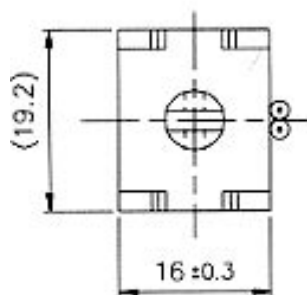
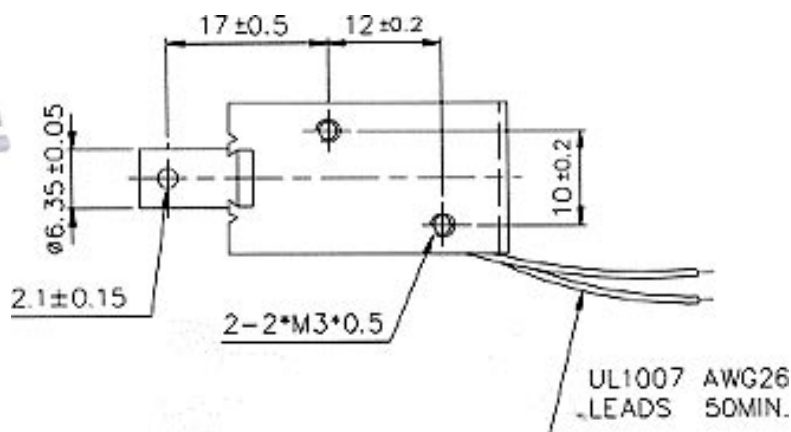
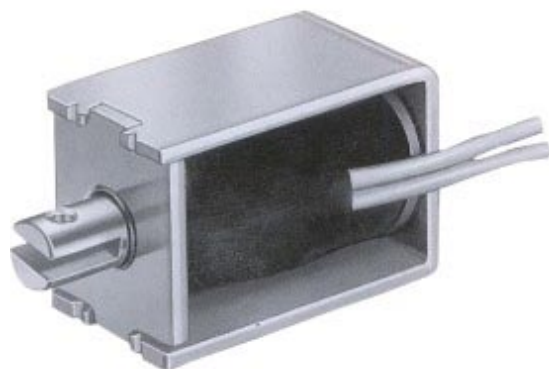
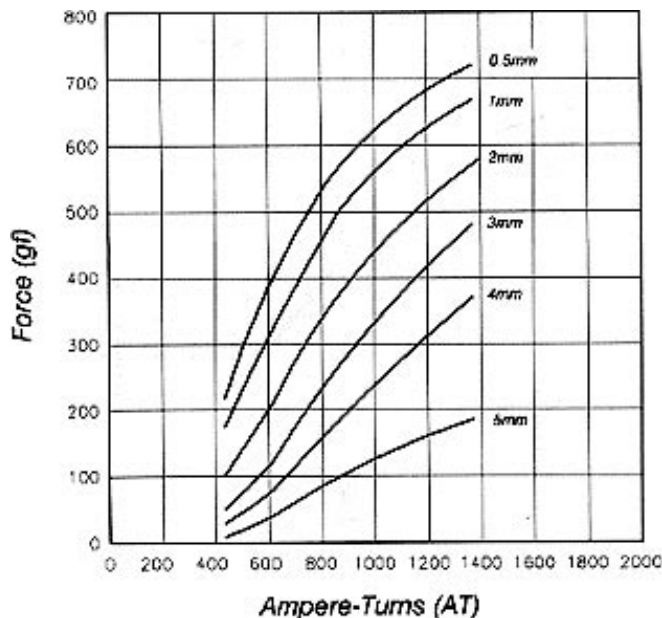
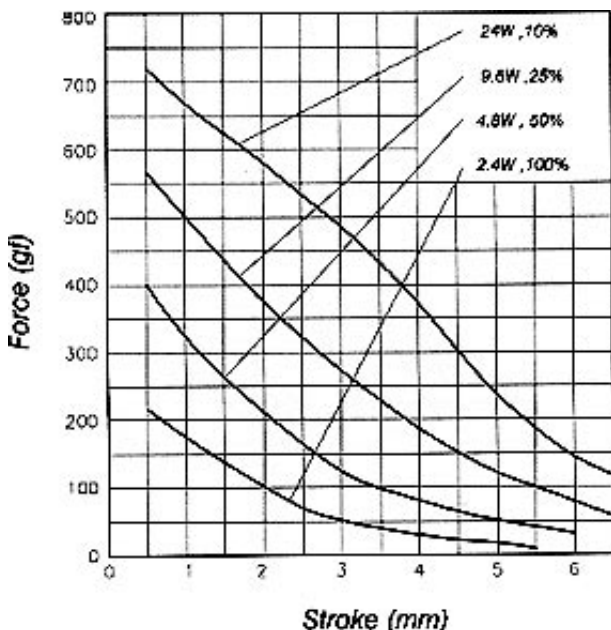

Plunger Weight: 5g / Total Weight: 42g

The Solenoid Company
 H. Kuhnke Ltd
 21 Abbey Enterprise Centre
 Premier Way
 Romsey
 Hampshire
 SO51 9AQ
 UK

Tel: +44 (0)1794 514445
 Fax: +44 (0)1794 513514
 Email: sales@thesolenoidcompany.com
 Web: www.thesolenoidcompany.com

The information shown on these pages is for guidance purposes only. The Solenoid Company accepts no responsibility for the use of this data. System designers are responsible for ensuring that these products are suitable for the relevant application.