

## D6 Series Rotary Solenoid

Voltage rating	V DC	24					205					V DC	Voltage rating	
ED* LK	%	100	44	27	17	5	100	34	20	12	5	%	ED* LK	
Current rating	A	0,56	1,13	1,75	2,70	8,60	0,54	0,165	0,279	0,430	0,980	A	Current rating	
Nominal resistance	Ω	42,7	21,3	13,7	9,0	2,8	3.818	1.241	735	476	209	Ω	Nominal resistance	
D 62, 25°	MA Ncm	12,0	21,0	24,5	28,5	40,0	11,0	21,5	25,5	29,5	38,0	Ncm	MA	D 62, 25°
	ME Ncm	25,0	31,0	34,5	38,0	44,5	23,0	31,0	35,0	38,0	44,0	Ncm	ME	
D 63, 35°	MA Ncm	9,0	15,5	19,0	23,0	33,0	7,5	16,0	21,0	24,0	31,0	Ncm	MA	D 63, 35°
	ME Ncm	22,0	27,0	30,0	32,0	36,0	20,0	27,0	30,0	32,0	35,5	Ncm	ME	
D 64, 45°	MA Ncm	6,0	11,5	15,0	19,0	28,5	5,0	12,0	16,0	20,0	27,0	Ncm	MA	D 64, 45°
	ME Ncm	20,0	25,0	27,0	29,0	30,5	19,0	25,0	27,0	29,0	30,5	Ncm	ME	
D 66, 65°	MA Ncm	3,2	7,4	10,5	14,5	23,5	2,6	7,5	11,0	15,0	22,0	Ncm	MA	D 66, 65°
	ME Ncm	19,5	23,0	24,0	25,0	24,0	17,5	23,0	24,0	25,0	24,0	Ncm	ME	
D 69, 95°	MA Ncm	1,3	3,3	4,7	7,0	13,2	1,1	3,2	5,2	7,6	12,0	Ncm	MA	D 69, 95°
	ME Ncm	15,0	17,0	17,0	16,6	14,2	14,2	17,0	17,0	16,6	14,0	Ncm	ME	

\* By using a cooling surface  $\geq 600 \text{ cm}^2$ , the permissible duty cycle can be extended up to 1.7x normal rating

MA = Initial torque  
 ME = End torque (5° before end of rotary angle)

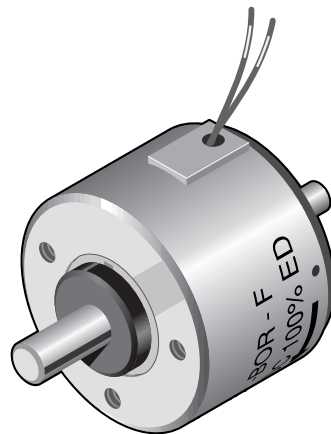

Coil terminals: - Flying leads  
 - Solder terminal box (6.3 DIN 46247)

Weight: appr. 600 g  
 Dyn. moment of inertia (rotational mass): appr.  $3.5 \cdot 10^{-6} \text{ kg m}^2$   
 Time constant: appr. 10–30 ms

All solenoids with MA > 4.8 Ncm are available with spring return, with a rating of MR = 4.0 Ncm approximately.

The operational voltage of 205 V DC results from rectifying 230 V AC with a bridge rectifier.

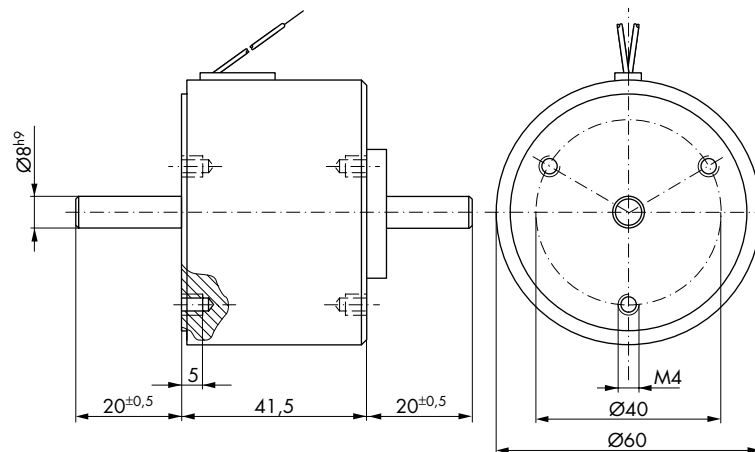

**Impulse Automation Limited**  
**United Kingdom**  
**Company Registration 665193**

Information shown in these data sheets are for guidance purposes only, no liability is accepted for any errors or omissions. The designer or user is solely responsible for the safe and proper use of these parts, assemblies or equipment described.

## D6 Series Ordering Information

D	6	3	-ROR-	- N -	24 V DC	100 % ED	Order specifications
D							Rotary solenoids
	6						
							Angular travel
		2					25°
		3					35°
		4					45°
		6					65°
		9					95°
			-ROR-				Shaft and rotation options
							Coil terminals
				F			Flying leads (20 cm standard length)
				N			Terminal box <sup>3)</sup>
							Nominal voltage
					24		Standard voltage
					205		(connected to 230 V AC with Si-bridge rectifier)
						100 % ED	Perm. duty cycle under air cooled conditions (LK)

Preferred types competitively priced and available on a quick delivery.

**D64-BOR-F-DS9420-24VDC 100%ED**

**D69-BOR-F-DS9420-24VDC 100%ED**

**DS9420** refers to a standard adjustable return spring.

<sup>3)</sup> Suits push-on connector 6.3 DIN 46247 and plug-in socket No. Z801.

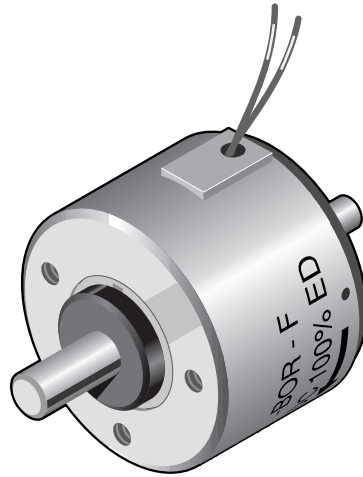

Insulation class: B (max. permissible temperature = 130 °C)  
 Test voltage: 2500 V (eff)  
 (D 2: 1500 eff)  
 Accessories: Plug-in socket Z801

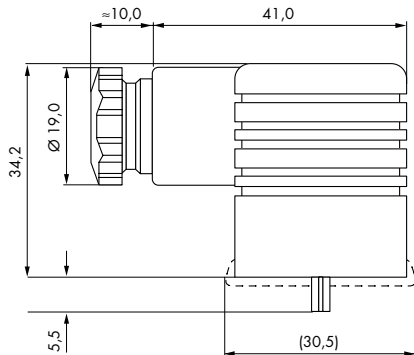

**Plug-in socket Z801**  
 Screw joint PG 9  
 for lead diameter 4.5 - 7 mm

**Plug-in socket Z811**  
 Screw joint PG 11  
 for lead diameter 6 - 9 mm  
 Plug-in socket with built in Si-bridge rectifier



**Impulse Automation Limited**  
**United Kingdom**  
**Company Registration 665193**

Information shown in these data sheets are for guidance purposes only, no liability is accepted for any errors or omissions. The designer or user is solely responsible for the safe and proper use of these parts, assemblies or equipment described.

# D6 Series Shaft & Rotation Options

## Shaft designs

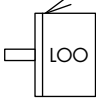
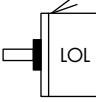
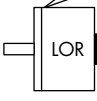
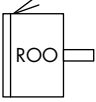
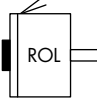
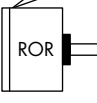
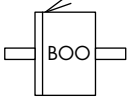
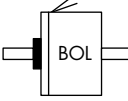
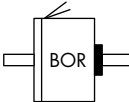
Normal	Spring return
	
	
	
	
	
	

The following types of rotary solenoids are available. Resulting in the following abbreviations for ordering:

### 1. letter

Direction of rotation (facing the output shaft)

- L** anti-clockwise rotation
- R** clockwise rotation
- B** shaft extensions both ends

### 2. letter

Centering shoulder

- O** standard type without mounting ring
- R** optional
- L** optional

### 3. letter

Return spring – the torque exerted by the spring is to be subtracted from the torque values given in the data sheets

- L** on the anti-clockwise shaft end
- R** on the clockwise shaft end
- O** no return spring fitted
- B** both sides

### Example 1

anti-clockwise rotation, no return spring, standard shaft length  
**LOO** -

### Example 2

shaft extensions on both ends, return spring on anti-clockwise rotation end  
**BOL** -

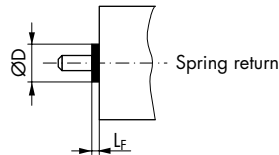

Spring return arrangement (with protection cap)

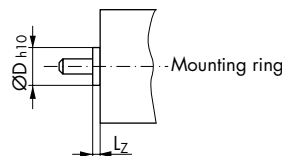

Mounting ring

Dimensions in mm	Solenoid size
	D6
Ø D	24,5
L <sub>F</sub>	6,0
Ø D <sub>h10</sub>	22,0
L <sub>Z</sub>	3,0

Impulse Automation Limited  
 United Kingdom  
 Company Registration 665193